

Magna



The perfect combination of power and efficiency



Magna





The design of Magna places the operator at the center, protecting him or her within a robust structure and ensuring that he or she is surrounded by a comfortable and functional space.

The size also conveys this model's power and solidity externally as well, as it has been created for the most demanding environments. The front of the machine, the elongated LED headlights, and the sleek shape lighten the bulk and emphasize the in-depth research that led to the development of this perfect combination of power and aesthetics.

Compartments designed for the extra accessories do not interfere with the original shapes either, rather they become part of the machine itself.

The technology on board improves the user experience and increases interaction, given that there are more functions and programs designed to reduce consumption, optimize cleaning times and lower cleaning costs.

Magna

Quality materials are at the heart of its robust core

The aesthetically pleasing design highlights the robust construction, suitable for demanding applications in industrial environments

The polyethylene which composes the body of the machine offers high resistance to impact.
It protects all of the internal parts of the machine in order to prevent possible damage during use



The aluminium of the chassis increases reliability over time

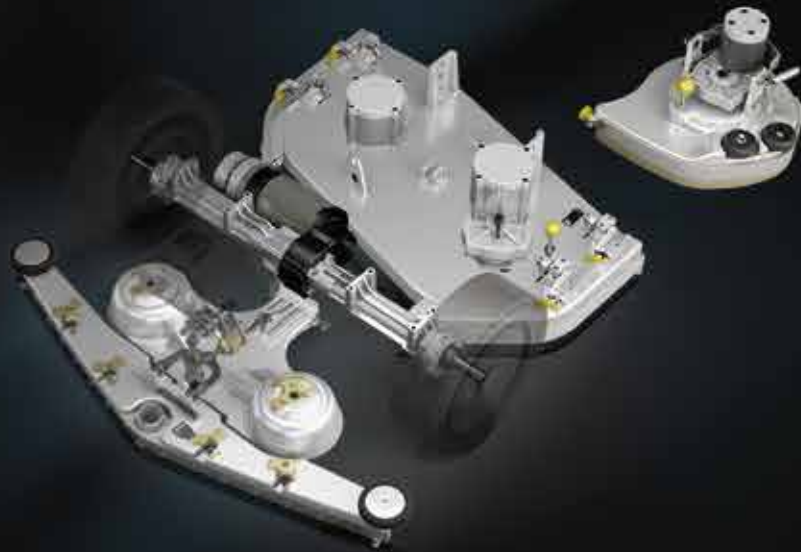

Magna

Comfort is essential for a job well done

The driving position offers full visibility and is spacious and accessible from both sides.

It has a comfortable seat with arm rests, plenty of space for the legs, an ergonomic steering wheel and all of the controls concentrated on the touch screen display.

The operator is at ease knowing he has complete control over the machine and can manage all of the activities from a comfortable position, which includes enabling all of the necessary functions in a simple and intuitive manner.



Boasting FNC and Eco Mode technology, the Magna is extremely quiet, which benefits the health of the operator and of any people nearby



The lateral paddles help to ensure the operator is always facing the direction of travel, with no distractions



The lowered footboard facilitates access from both sides and allows the operator to sit easily without any effort



Magna

Comfort is essential
for a job well done



NO TRAINING

The integrated video tutorials demonstrate how to perform routine and extraordinary maintenance

SERVICE LIGHTS



The exclusive lights pack offers increased visibility of the parts which could require operator inspection, illuminating the relative zones with LED lights



FFF – FIMAP FAST FILL

Automatic system for filling the fresh water tank, lets the operator perform other activities while the tank quickly fills up



SPRAY GUN

Facilitates quick and easy rinsing of the recovery tank at the end of the operation



YELLOW COLOUR-CODED PARTS

Parts which must be cleaned regularly at the end of every shift are colour coded in yellow for easy identification, saving time and making sure that your scrubbing machine is kept in perfect condition at all times

Magna

Equipped to provide you with the best performance possible in any environment and under any conditions



Dual 3-stage vacuum motor

Effective vacuum system which leaves the floor dry with no risk of slipping



VACUUM WAND

Enables cleaning of areas that are difficult to reach with the machine and completing the operation every time

BRUSHLESS MOTORS

For guaranteed reliability even in aggressive environments, with no maintenance required



FLR-FIMAP LONG RANGE
Increases productivity by up to 70%



RAMP UP

Astonishing performance in any situation

A special electronic control modulates power precisely, enabling the machine to climb ramps of up to 18% easily and smoothly, with no interruption or loss of power delivery.

Adjustable pressure on the brushes

With a brush pressure which can be set to up to 150 Kg, the machine can tackle even the most stubborn dirt





POWER MODE

When more scrubbing power is needed, activating Power Mode increases the delivery rate of detergent solution and boosts brush pressure and vacuum power for the time necessary to tackle heavy duty cleaning

REAR VIEW CAMERA

Lets the operator monitor cleaning results in real time from the display, without taking his or her eyes off the direction of travel

Light steering for even more operator comfort

The dual front wheel reduces the specific pressure exerted on the floor, making the steering action lighter. This solution also increases manoeuvrability and prevents marking, even on the most delicate floors

A LATERAL BRUSH FOR EVEN MORE GREATER PRODUCTIVITY

The third brush moves laterally to facilitate cleaning along walls or shelves, increasing productivity by up to 15%



Save time by working faster

Up to 6 Km/h in work mode and 9 Km/h in transfer mode

Great autonomy

Work for up to 5 hours non-stop

Magna

Designed to be the safest machine
in any situation

ACTIVE TECHNOLOGIES to prevent accidents



ANTI-COLLISION
SYSTEM

The anti-collision system
detects obstacles
when reversing



Safety is paramount

The Magna is equipped with a host of safety systems and features to keep the operator in complete control at all times, working with total peace of mind



REAR VIEW
CAMERA

Increases the safety of
reverse manoeuvres

Designed to be the safest machine in any situation

ACTIVE TECHNOLOGIES to prevent accidents



TOUCH SCREEN
DISPLAY

Enhances visibility in dim light



DESCENT
CONTROL

Maintains a constant speed when driving downhill, and prevents sudden increases in speed caused by gravity



STEERING
WHEEL
CONTROLS

The steering wheel controls offer the operator even greater control when cleaning, and also improve safety by eliminating distractions and letting the operator keep his or her eyes on the zone ahead of the machine



STOP&GO

The traction control system, which brakes and holds the machine when the accelerator pedal is released, provides assistance for both uphill and downhill gradients



CRUISE
CONTROL

Control device letting the operator set the required speed



ELECTROBRAKE

Is automatically operated when the machine stops. It works as a safety parking brake



ESC - ELECTRONIC
STABILITY CONTROL

Automatically reduces speed when steering without the operator using the brake



HYDRAULIC
DRUM BRAKES

Self-adjusting, guaranteeing the best braking performance



OVERHEAD
GUARD

To protect operators working in warehouses and logistics centers

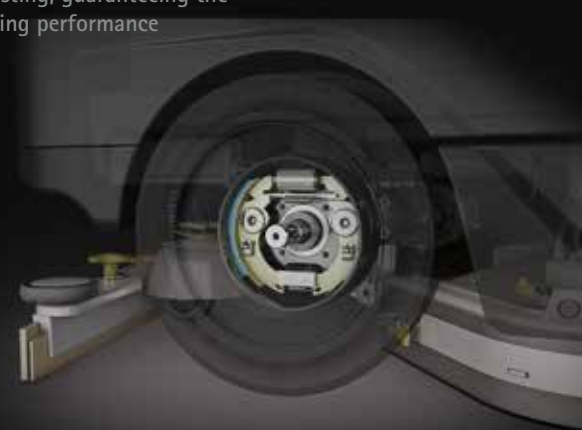



Front and rear LED headlights maximize work safety in all conditions

LED HEADLIGHTS



Any questions? Magna has all the answers: the video tutorials help the operator in every phase of the job

VIDEO TUTORIALS

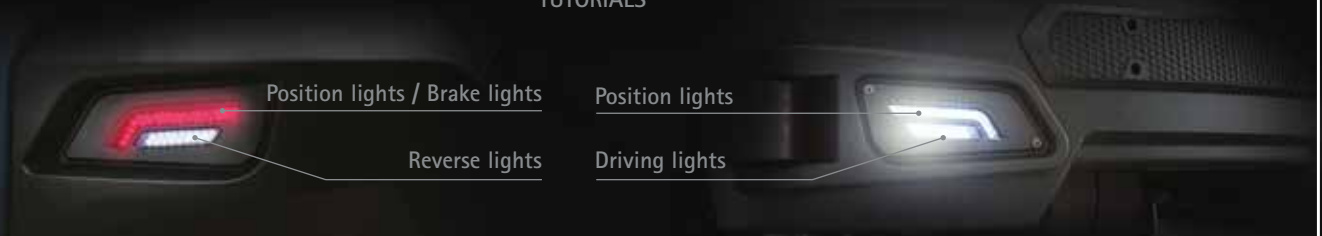

PASSIVE SYSTEMS to help the operator in case of emergency



Emergency sms



SOS DEVICE

Reduces time to service in case of emergency. The red button sends an sms alert to receive a prompt help, reducing downtimes



EMERGENCY STOP

By pressing a single button the machine stops immediately

Magna

Driving system with touchscreen display which transforms cleaning into a revolutionary experience



Touchscreen Display



iD-intelligent Drive



TOUCH SCREEN
DISPLAY



LOG-IN WITH
PASSWORD



ZONE PROGRAMS



CRUISE
CONTROL



SUSTAINABLE
CLEANING



SEVERE
CLEANING



REAR VIEW
CAMERA



ANTI-COLLISION
SYSTEM



VIDEO
TUTORIALS



The operator is the center of a high-tech universe,
where everything is easy, intuitive and dynamic

All functions and activities are managed from a single interface,
where a mere touch of the finger offers access to an extraordinary
choice of customizable features to satisfy all types of requirements with extreme simplicity.

The high definition colour display offers the same intuitive experience as a smartphone



LOG-IN WITH PASSWORD
To protect your investment



ZONE PROGRAMS
For all the performance you'll ever need



ECO MODE
To protect the environment



POWER MODE
For maximum power when you need it



REAR VIEW CAMERA
To keep everything under control



VIDEO TUTORIALS
For a more efficient, fast and easy
operator training



FIMAP FLEET MANAGEMENT

Developing new technology to improve efficiency is one of the core missions of Fimap.

An example of this is FFM, the Fimap Fleet Management system which collects the data sent by the machines and transforms it into valuable information accessible to you easily in real time, 24/7, from your smartphone, through the app My.Machine.

Being constantly connected to your machines will help you operate them even more efficiently and effectively.

My.Machine lets you know where the machines are, if the operation is being carried out according to plans and at the scheduled time.

The machines health status is constantly monitored. In the very unlikely event of a breakdown, you'll receive an alert notification directly on your smartphone, allowing you to take action promptly and immediately call the technical support.

You can check the battery conditions and the quality of the charges in order to optimize battery endurance and life cycle.

Discover FFM and experience
the advantages of being constantly connected
with the My.Machine app!



Watch the video



My.Machine



Keep tabs on your machines remotely when you want and from wherever you want!



GEOLOCALISATION

You know where
your machines are



USAGE
INFORMATION

You know how your
machines are used



HEALTH STATUS

You know the health
status of machines
and batteries



ENVIRONMENTAL
IMPACT

You can check
the machine
consumption per
intervention

Sustainable solutions to protect the environment

Fimap sustainable technological solutions guarantee a reduction in cost per sq.m. cleaned, more working autonomy, time savings and better cleaning results, enabling you to cover more surface area with the same resources.



The Eco Mode function helps prevent water, detergent and energy consumption by using only the quantities you need and nothing more



START&STOP

When the machine is idle, the brush motor, the vacuum motor, the traction and detergent pump will turn off automatically, reducing costs and emissions. All the functions are reactivated as soon as the operator touches the accelerator again



WATER



FLR-FIMAP LONG RANGE

Reduces water and detergent consumption per cleaning operation by up to 66%*. This is a system which recycles detergent solution to increase autonomy: to scrub more sq.m. while using less resources



FSS-FIMAP SOLUTION SAVER

Water and detergent quantities are separately dosed, reducing consumption by up to 50%



FWF-FIMAP WATER FLOW

Ensures uniform cleaning results across the entire working width on the first pass, optimising detergent solution consumption

ENERGY



FES-FIMAP ENERGY SAVER

Reduces energy consumption by up to 35%

LED TECHNOLOGY

Up to 80% lower energy consumption than conventional headlights. The LED headlights consume much less energy than conventional headlights, offer a longer lifespan and illuminate with a brilliant white light similar to natural daylight



NOISE LEVELS



FNC-FIMAP NOISE CANCELLING

Reduces sound pressure

*Saving calculated on a triple recycling cycle

Magna

Choose the right version
for your sector



DISC
with 2 disc brushes
or 2 pad holders

CYLINDRICAL
with 2 cylindrical brushes and a debris
hopper for small sized solid debris



Basic



PLUS

Magna

Enhance it with the most suitable accessories for your specific requirements

OPTIONALS



Vacuum wand



Spray gun



Seat with armrests and seat belt



FFF-FIMAP FAST FILL



Side scrubbing brush
(available for disc versions)



2 side sweeping brushes increase
cleaning performance along walls
(available for Cylindrical versions)



Dual 3-stage vacuum motor



FFM-FIMAP FLEET MANAGEMENT



Front and rear LED headlights kit



Rear/front super elastic wheels kit, for minimal vibration and increased comfort

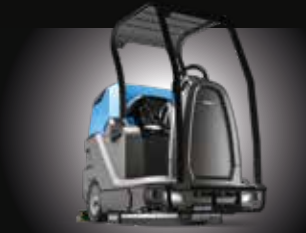

Overhead guard and bumpers



FSS-FIMAP SOLUTION SAVER



FLR-FIMAP LONG RANGE

ACCESSORIES

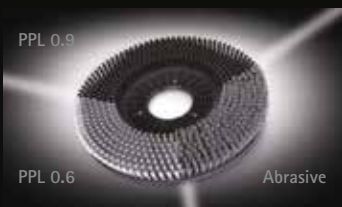

A wide choice of disc or cylindrical brushes in PPL is offered, 0.6 or 0.9 thick. These offer the perfect solution for dealing with any type of dirt on any floor

Abrasive brushes:
Ideal for heavy duty cleaning on industrial surfaces



Rear squeegee rubber blades

33 SHORE (PARA): For maintenance cleaning of smooth floors

40 SHORE (PARA): For stubborn dirt on floors with joints

POLYURETHANE: For heavy duty cleaning on industrial floors, even with wide gaps

USER EXPERIENCE	Magna	Magna PLUS	Magna Cylindrical	Magna Cylindrical PLUS
iD-Intelligent Drive:	-	•	-	•
- 5 inch high resolution colour touch screen	-	•	-	•
- Log-in with password	-	•	-	•
- Zone programs	-	•	-	•
- Cruise control	-	•	-	•
- Eco Mode	-	•	-	•
- Power Mode	-	•	-	•
- Rear view camera	-	•	-	•
- Anti-collision system	-	•	-	•
- Video tutorials	-	•	-	•
COMFORT				
Hour meter	•	•	•	•
Cleaning solution level indicator	•	•	•	•
Water and detergent empty tank lights	-	•	-	•
Vacuum wand kit	○	○	○	○
Spray gun kit	○	○	○	○
Seat with armrests	○	•	○	•
FFF (Fimap Fast Fill)	○	○	○	○
PRODUCTIVITY				
Pressure adjustment	-	•	-	•
Extra pressure	•	-	•	-
Right-hand side scrubbing brush	○	○	-	-
2 sweeping side brushes	-	-	○	○
3-stage vacuum motor	•	•	•	•
2 3-stage vacuum motors	○	○	○	○
FFM (Fimap Fleet Management) with SOS device	○	○	○	○
Rear side splash guards kit	•	•	-	-
SAFETY				
Blinking light	•	•	•	•
Driving LED headlights kit (front-back)	○	-	○	-
Driving headlights kit (front-rear) and LED warning lights	-	•	-	•
Super elastic wheels kit (front-rear)	○	○	○	○
Ramp up	•	•	•	•
Stop&Go	•	•	•	•
Descent control	•	•	•	•
ESC (Electronic Stability Control)	•	•	•	•
Emergency Stop	•	•	•	•
Overhead guard*	○	○	○	○
Front bumper kit	○	○	○	○
Seat with armrests and seat belts	○	•	○	•
ENVIRONMENT				
FSS (Fimap Solution Saver)**	○	○	○	○
FLR (Fimap Long Range)**	○	○	○	○
FNC (Fimap Noise Canceling)	•	-	•	-
FES (Fimap Energy Saver)	•	•	•	•
FWF (Fimap Water Flow)	•	•	-	-
Start&Stop	•	•	•	•

* Can only be installed if the front bumper kit is present

** The two devices cannot be installed together

• STANDARD

○ UPON REQUEST

- NOT AVAILABLE

DIMENSIONS AND TECHNICAL DATA

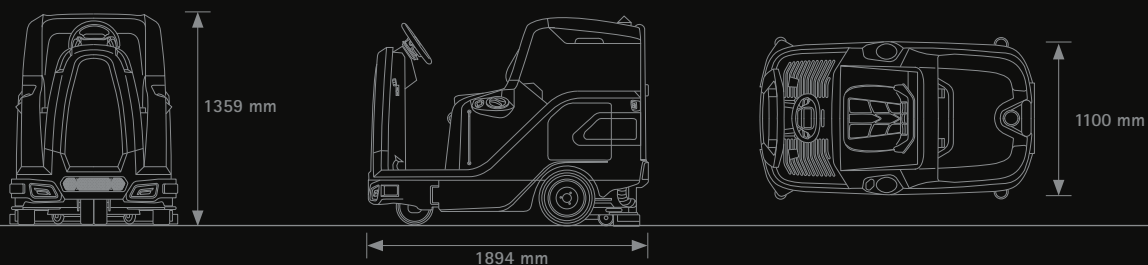

TECHNICAL DATA		Magna / Plus	Magna Cylindrical / Plus
Working width	mm	900	825
Working width with side brushes	(no.) mm	(1) 1050	(2) 1200
Squeegee width	mm	1100	1100
Disc brushes Ø	(no.) mm	(2) 460	-
Cylindrical brushes Ø	(no.) mm	-	(2) 210x856
Side brushes Ø	(no.) mm	(1) 290	(2) 450
Solution tank	l	190	190
Recovery tank	l	200	200
Supply/Traction	V	36/aut.	36/aut.
Acoustic level (ISO 11201)	dB (A)	<70	<70
Brush motors	(no.) V/W	(2) 36/750	(2) 36/750
Suction motor	V/W	36/650	36/650
Suction vacuum	mbar	190	190
Traction motor	V/W	36/900 DC / 36/900 AC	36/900 DC / 36/900 AC
Brush rpm (central / side)	rpm	180 / 140	550 / 75
Brush pressure	kg	45÷150	30÷60
Forward speed	km/h	0÷9	0÷9
Minimum aisle turn	mm	2450	2450
Gradeability (Working / Transport at gross weight / Transport at net weight)	%	7/10/18	7/10/18
Batteries	(no.) V/Ah C5	(2) 18/360	(2) 18/360
Batteries weight	kg	416	416
Machine weight (without battery – without side brushes)	kg	450	440
Working capacity	up to sqm/h	5400	5000
Battery compartment dimensions (L x h x w)	mm	960 x 400 x 505	960 x 400 x 505

FIMAP LIFE

Your best investment in cleaning

The service package that gives you more of what you need for less than you think!
We want you to deal only with your work, leave everything else to Fimap Life!

📱 FIMAP INTELLIGENCE



Using powerful software, unique of its kind, and on-site advice, Fimap supports you in choosing the ideal model and its optimum configuration, according to the type of environment to be cleaned and your requirements.

€ FIMAP FINANCE



Fimap offers various financial solutions that can be adapted perfectly to your business.

🔧 FIMAP MAINTENANCE



With Fimap Maintenance will not have to worry about maintenance of the product: your Fimap machines will always be as new and ready for use. Choose from the three Service Packs offered - Light, Smart or Full - to suit the needs of your job.

👤 FIMAP FLEET MANAGEMENT



Fimap Fleet Management (FFM) service transforms the data received from the machines into information that is essential to improve the performance and productivity of the fleet. Through the app My.Machine it provides a comprehensive overview of the machines in use, helping you to reduce costs and optimize cleaning times.

🌐 FIMAP NETWORK



Fimap is always there for you: our global network of certified dealers guarantees a rapid response support service, wherever you are.

🎓 FIMAP ACADEMY



In a market that is becoming more and more competitive, Fimap offers a new support service for cleaning contractors, a growth opportunity for the professionals of today and tomorrow. This dedicated training program addresses various subjects that are relevant for the daily requirements of customers.

CERTIFICATIONS

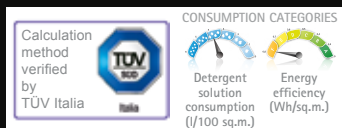

CONSUMPTION CATEGORIES

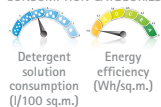

For any additional information or for a demo please contact your usual Fimap dealer



FIMAP spa – Via Invalidi del Lavoro, 1 – 37059 S. Maria di Zevio – Verona – Italy
Tel. +39 045 6060411 – Fax +39 045 6060417 – E-mail: fimap@fimap.com



Scan the QR Code
with your Smart Phone
and visit our web-site